

INSTRUCTION MANUAL

ACD-14 TECH CLAMP

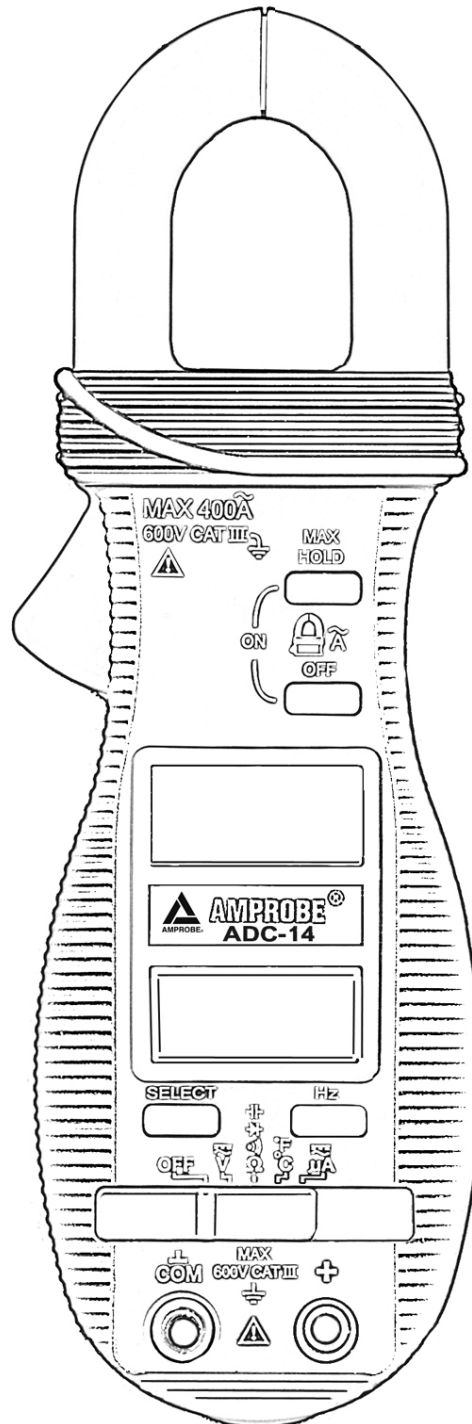

 **AMPROBE®**

Congratulations! Your new instrument has been crafted according to quality standards and contains quality components and workmanship. It has been inspected for proper operation of all of its functions and tested by qualified factory technicians according to the long-established standards of AMPROBE.

1) SAFETY

This manual contains information and warnings that must be followed for operating the instrument safely and maintaining the instrument in a safe operating condition. If the instrument is used in a manner not specified by the manufacturer, the protection provided by the instrument may be impaired.

This meter meets the requirements for double insulation to IEC61010-2-032(1994), EN61010-2-032(1995), UL3111-2-032(1999): **Category III 600 Volts ac and dc.**

OVERVOLTAGE INSTALLATION CATEGORIES, PER IEC61010:

OVERVOLTAGE CATEGORY II: Equipment of OVERVOLTAGE CATEGORY II is energy-consuming equipment to be supplied from the fixed installation.

Note – Examples include household, office, and laboratory appliances.

OVERVOLTAGE CATEGORY III: Equipment of OVERVOLTAGE CATEGORY III is equipment in fixed installations.

Note – Examples include switches in the fixed installation and some equipment for industrial use with permanent connection to the fixed installation.

OVERVOLTAGE CATEGORY IV: Equipment of OVERVOLTAGE CATEGORY IV is for use at the origin of the installation. Note – Examples include electricity meters and primary over-current protection equipment.

TERMS IN THIS MANUAL

 **WARNING:** Identifies conditions and actions that could result in serious injury or even death to the user.

 **CAUTION:** Identifies conditions and actions that could cause damage or malfunction in the instrument.

⚠ WARNING:

To reduce the risk of fire or electric shock, do not expose this product to rain or moisture. The meter is intended only for indoor use.

To avoid electrical shock hazard, observe the proper safety precautions when working with voltages above 60 VDC or 30 VAC rms. These voltage levels pose a potential shock hazard to the user.

Inspect test leads, connectors, and probes for damaged insulation or exposed metal before using the instrument. If any defects are found, replace them immediately.







Do not touch test lead tips or the circuit being tested while power is applied to the circuit being measured. To avoid accidental short circuit of bare (un-insulated) hazardous live conductors or bus bars, switch them off before insertion and removal of the current clamp jaws. Contact with the conductor could result in electric shock.

Keep your hands/fingers behind the hand/finger barriers that indicate the limits of safe access of the meter and the test leads during measurement.

⚠ CAUTION:

Disconnect the test leads from the test points before changing meter functions.

INTERNATIONAL ELECTRICAL SYMBOLS

	Caution! Refer to the explanation in this Manual
	Caution! Risk of electric shock
	Earth (Ground)
	Double Insulation or Reinforced insulation
	Fuse
	AC--Alternating Current
	DC--Direct Current

2) CENELEC Directives

This instrument conforms to CENELEC Low-voltage directive 73/23/EEC and Electromagnetic compatibility directive 89/336/EEC

3) PRODUCT DESCRIPTION

Note: Please refer to Specification Section for function details.

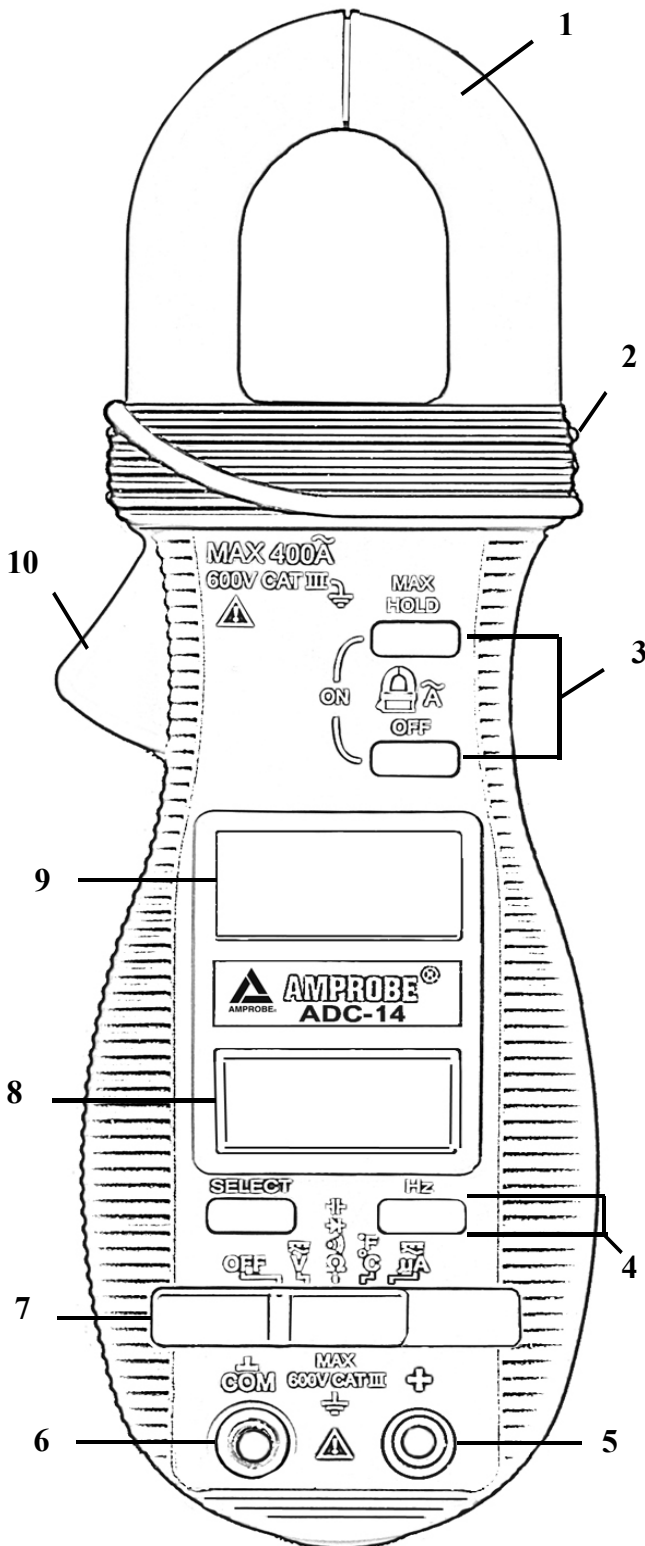

1) Clamp Jaw for AC current magnetic field pick up

2) Hand/Finger Barrier to indicate the limits of safe access of the meter during measurement

3) Power ON/OFF buttons for ACA current function and MAX/Hold features

4) Push-button for frequency selection

5) Input Jack for all functions EXCEPT clamp-on ACA current function

6) Common (Ground reference) Input Jack for all functions EXCEPT clamp-on ACA current function

7) Slide-switch Selector to turn the lower display ON/OFF and to Select functions

8) Lower Display: for Input Jack functions
3-3/4 digits 4000 counts LCD

9) Upper Display: for ACA current
Clamp-on
3-3/4 digits 4000 counts LCD

10) Jaw trigger for opening the ACA current clamp jaw

4) OPERATION

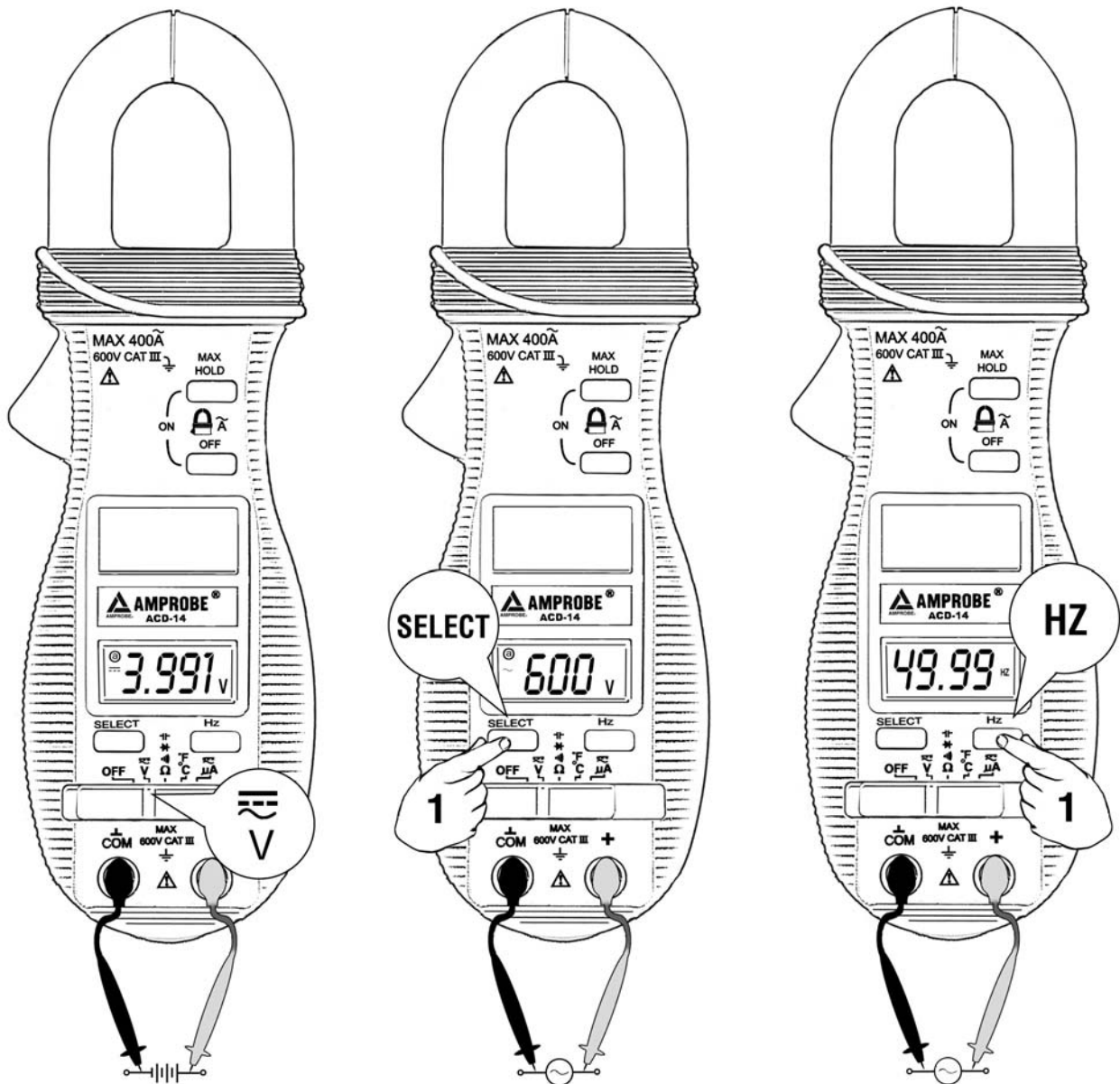

DC Voltage, AC Voltage, Hz Frequency functions

Inputs are made through the test lead terminals. Move the slide-switch to the “V” position. The unit defaults at DC voltage. Press **SELECT** button momentarily to **select AC voltage**.

To activate the **Hz Frequency** function, press the **Hz button** momentarily.

Note: 400.0mV range is designed with 1000M Ω high input impedance for least current drain in measuring small signals, and can cope better with most commercially available voltage output transducers/adapters. The non-zero display reading is normal when the meter inputs are open circuit, which will not affect actual measurement accuracy. The

meter will show close to zero reading when the inputs are shorted. Open input is actually a floating condition, which is not a zero-volt-input condition.

Note: Hz input sensitivity varies automatically with function range selected while activating the Hz function. Lowest range has the highest sensitivity, and the highest range has the lowest sensitivity. Activating the Hz function *WHILE* measuring the specific function signal (auto ranging) can automatically select the best sensitivity range to avoid electrical noise that may cause unstable Hz reading. However, if the Hz reading shows zero due to insufficient sensitivity, activate the Hz function *BEFORE* measuring the specific function signal. The meter is then in the lowest range and can select the highest sensitivity range.

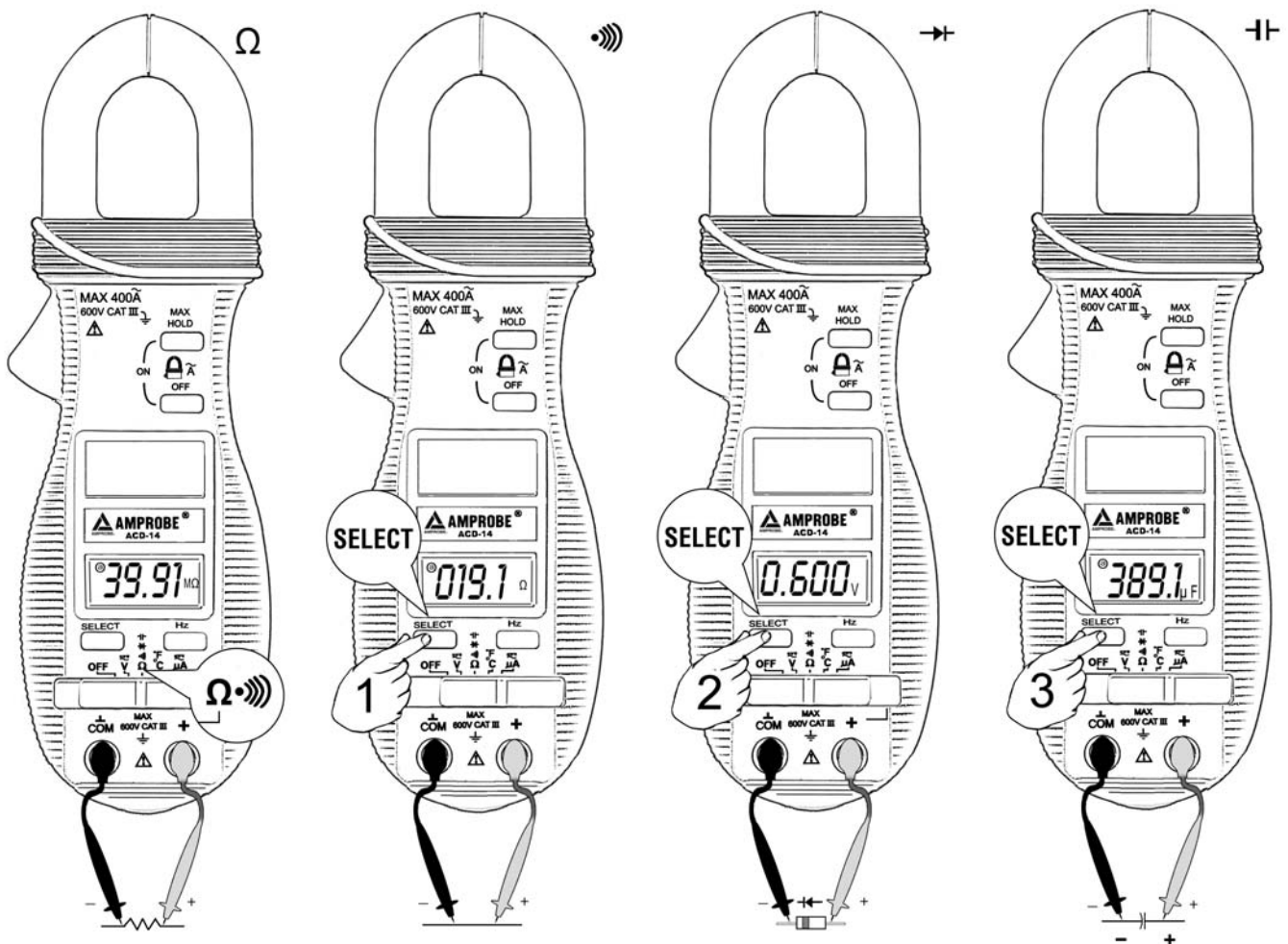

⚠ Caution

Measuring Resistance, Continuity, Diode or Capacitance function on a live circuit will produce false results and may damage the instrument. In many cases the suspected component must be disconnected from the circuit to obtain an accurate measurement reading.

Ω Resistance, and \rightarrow) Continuity functions

Inputs are made through the test leads terminals. Move the slide-switch to the “ Ω ” position. The unit defaults at Ω . Press **SELECT** button momentarily to select \rightarrow) Continuity function, which is convenient for checking wiring connections and operation of switches. A continuous beep tone indicates a complete wire.

\rightarrow Diode test function

Inputs are made through the test lead terminals. Move the slide-switch to the “ Ω ” position. The unit defaults at Ω . Press **SELECT** button momentarily 2 times to select \rightarrow Diode test function.

Normal forward voltage drop (forward biased) for a good silicon diode is between 0.400V to 0.900V. A reading higher than that indicates a leaky diode (defective). A zero reading indicates a shorted diode (defective).

An **OL** indicates an open diode (defective). Reverse the test leads connections (reverse biased) across the diode. The digital display shows OL if the diode is good. Any other readings indicate the diode is resistive or shorted (defective).

\rightarrow Capacitance function

Inputs are made through the test leads terminals. Move the slide-switch to the “ Ω ” position. The unit defaults at Ω . Press **SELECT** button momentarily 3 times to select \rightarrow Capacitance function.

CAUTION

Discharge capacitors before making any measurement. Large value capacitors should be discharged through an appropriate resistance load.

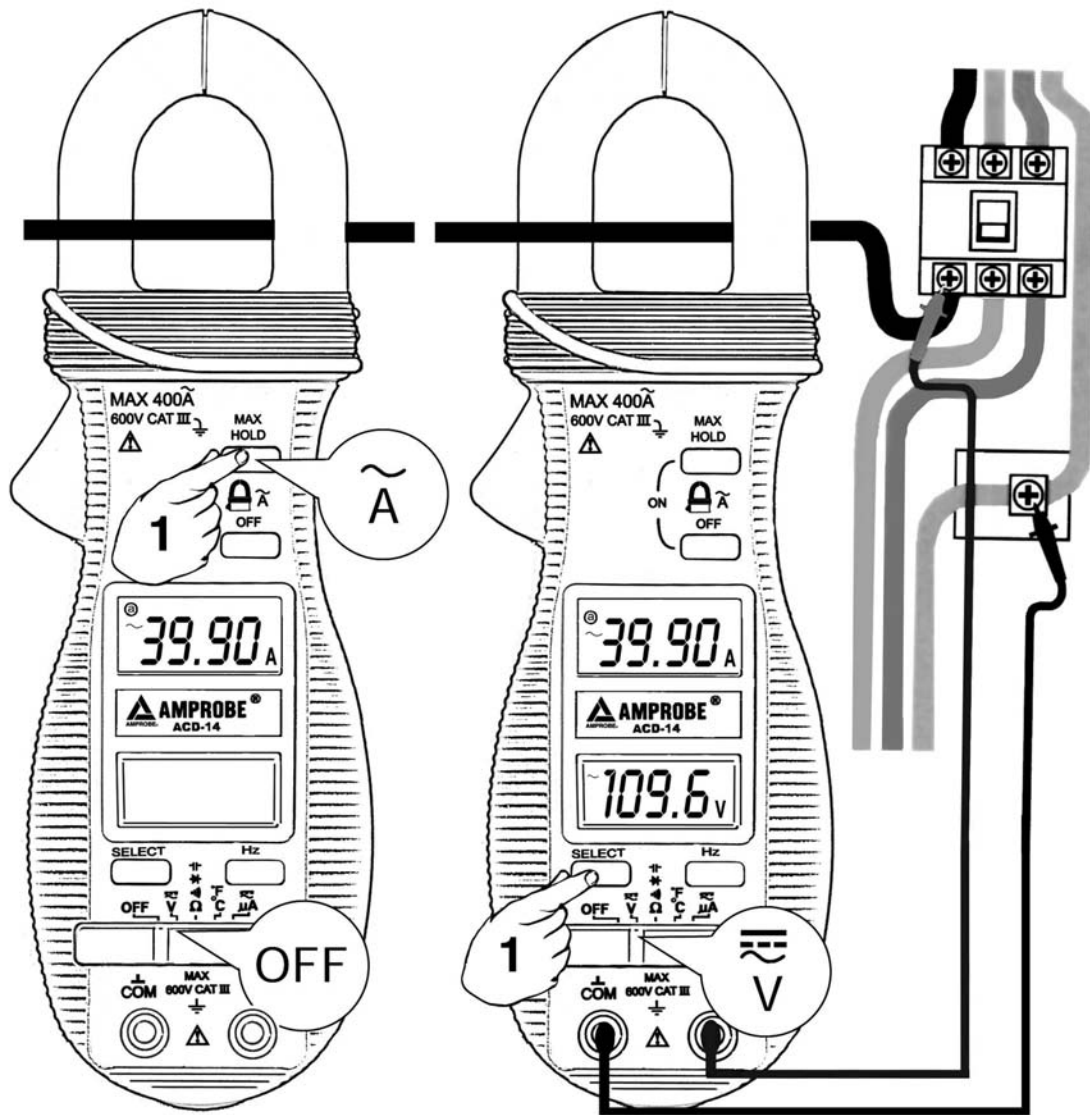

ACA Current clamp-on function

Inputs are made through the clamp on jaws for non-invasive ACA current measurements.

Press the **OFF** push button momentarily to power **on and off** the separate ACA function (upper) display. The **MAX HOLD** push button can also be used to power on this function. This twin ACA function display can be used simultaneously with voltage measurements or any of the other slide-switch functions (lower display) or it can be used alone.

⚠ CAUTION

Clamp the jaws around only one single conductor of a circuit for load current measurement. Enclosing more than one conductor of a circuit will result in differential current (like identifying leakage current) measurement.

Make sure the jaws are completely closed, or else it will introduce measurement errors.

Strong Electro-magnetic field environments such as high-current transformers, motors and conductors may affect measurement accuracy.

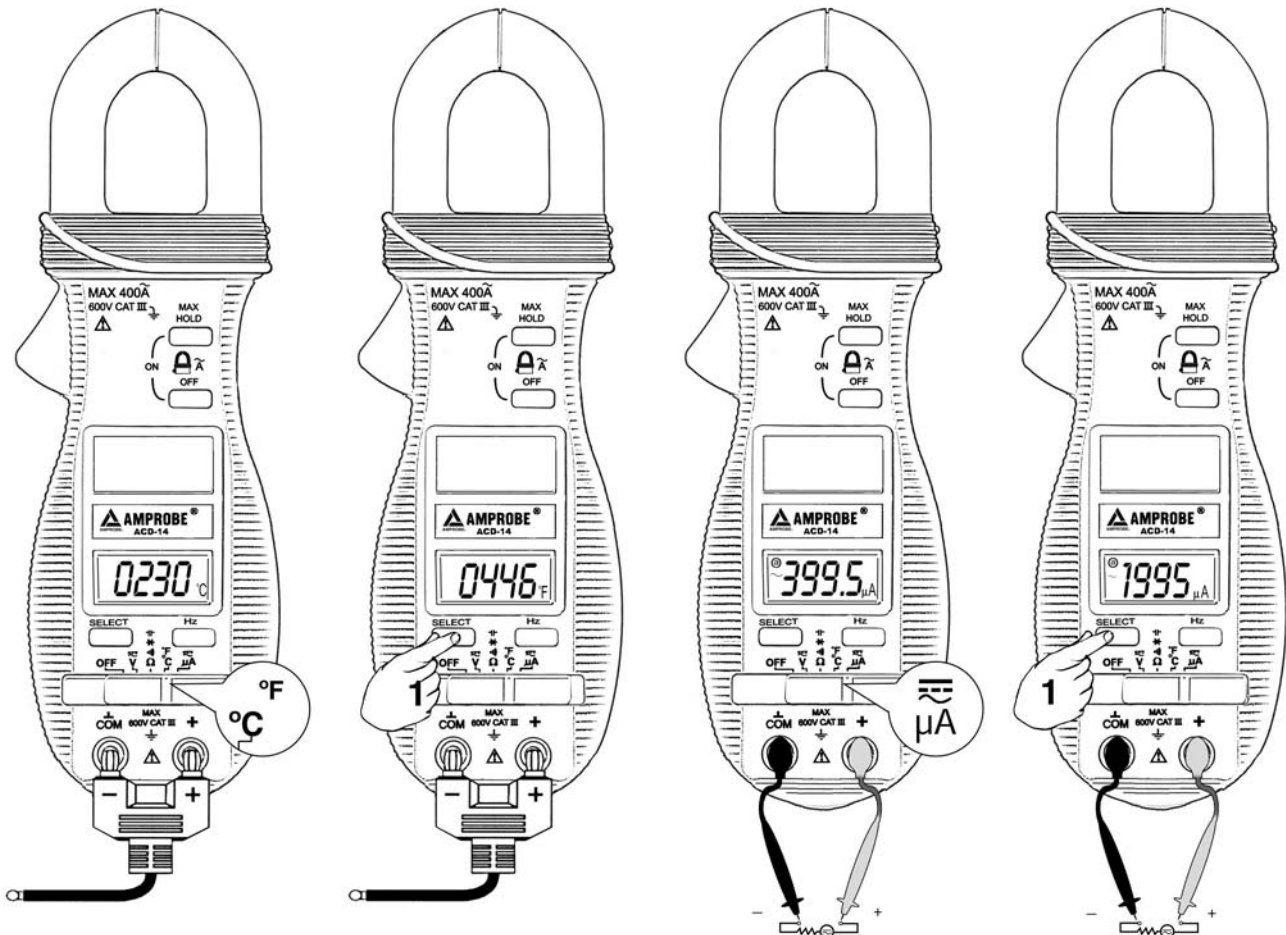

Temperature function

Insert the banana plug type-K temperature bead probe (TPK-59), observing the proper **+** **-** polarities. Move the slide-switch to the “°F/°C” position. The unit defaults at degree C (Celsius). Press **SELECT** button momentarily to select **degree F** (Fahrenheit).

µA Current function

Inputs are made through the test leads terminals. Move the slide-switch to the “µA” position. The unit defaults at **DC**. Press **SELECT** button momentarily to select **AC**.

You can select the **Hz** function by momentarily pressing the **Hz** button.

Application notes:

- 1) The DC μA function is designed especially for HVAC/R flame sensor applications. The $0.1\mu\text{A}$ resolution is useful for identifying the minute current changes in flame detector applications. Flame signal current check should indicate steady flame signal of at least $2\mu\text{A}$ for a rectification type, $1.5\mu\text{A}$ for an ultraviolet type, or $8\mu\text{A}$ for self-checking systems. If a flame signal current with inadequate strength or fluctuation beyond 10%, check the following to avoid the risk of unwanted flame relay dropout:

1.1) For gas or oil flames (Minipeeper):

- Low supply voltage
- Detector location
- Defective detector wiring
- Dirty viewing windows
- Faulty Minipeeper

1.2) For oil flames (Photocell):

- Detector location & wiring
- Smoky flame or poorly adjusted air shutter
- Faulty Photocell
- Temperature over 165°F (74°C) at photocell

1.3) For gas flames (Flame Rod):

- Ignition interference (A flame signal current difference with the ignition both on and off greater than $0.5\mu\text{A}$ indicates the presence of ignition interference)
- Insufficient ground (must be at least 4 times the detector area)
- Flame lifting off burner head (ground), or not continuously in contact with the flame rod
- Temperature in excess of 600°F (316°C) at the flame electrode insulator, causing short to ground.

HOLD

The hold feature freezes the **upper ACA display** for later viewing. Press the **HOLD** button momentarily to activate or exit this feature.

MAX

The *Max* feature compares and displays the measured maximum value (on the **upper ACA display**) as fast as 25ms with auto-ranging capability. Press the **MAX** button for 1 second or more to activate or exit this feature.

Auto-ranging

When there is more than one measuring range under a selected meter function, the LED annunciator “a” turns on in the upper left corner. The meter will automatically switch to the best resolution range when making measurements. No manual ranging selection is required.

Auto Power Off (APO)

When the meter is on, the Auto Power Off (APO) feature will switch the meter into a sleep mode automatically to extend battery life after approximately 30 minutes of the last front panel activity. To wake up the meter from APO, press the buttons momentarily or move the slide-switch to the OFF position and then back on again. Always set the slide-switch to the OFF position manually when the meter is not in use.

5) MAINTENANCE

WARNING

To avoid electrical shock, disconnect the meter from any circuit, remove the test leads from the input jacks and turn OFF the meter **Before** opening the case. Do NOT operate with open case.

Trouble Shooting

If the instrument fails to operate, first check the batteries and test leads etc., and replace as necessary. Double check the operating procedures as described in this User's Manual.

If the instrument voltage-resistance input terminal is subjected to a high voltage transient (e.g. lightning or switching surge) by accident or abnormal conditions of operation, the series fusible resistors will be blown (become high impedance) like fuses to protect the user and the instrument. Most measuring functions through this terminal will then be an open circuit. A qualified technician should then replace the series fusible resistors and the spark gaps. Refer to the LIMITED WARRANTY section for obtaining warranty or repair service.

Cleaning and Storage

Periodically wipe the case with a damp cloth and mild detergent; do not use abrasives or solvents. If the meter is not to be used for periods of longer than 60 days, remove the batteries and store them separately.

Battery replacement

The meter uses 2 standard 3V alkaline button batteries (ANSI/NEDA-5004LC, IEC-CR2030).

The lower battery is used for the slide-switch functions, and the upper battery is used for the upper display ACA function separately.

Low Battery Indication: When the battery voltage drops below approx. 2.4V, a battery symbol will appear in the upper right corner of the LCD display, indicating that the battery needs replacing.

To replace the batteries, loosen the two screws from the case bottom and remove the bottom case. Slide the battery out the side of the holder (see example below) and replace with a new battery (observe polarity). Replace the bottom case. Note: Take care to insure that the two (2) springs (located near the lower battery) line up with the speaker in the rear cover.

Re-fasten the screws.

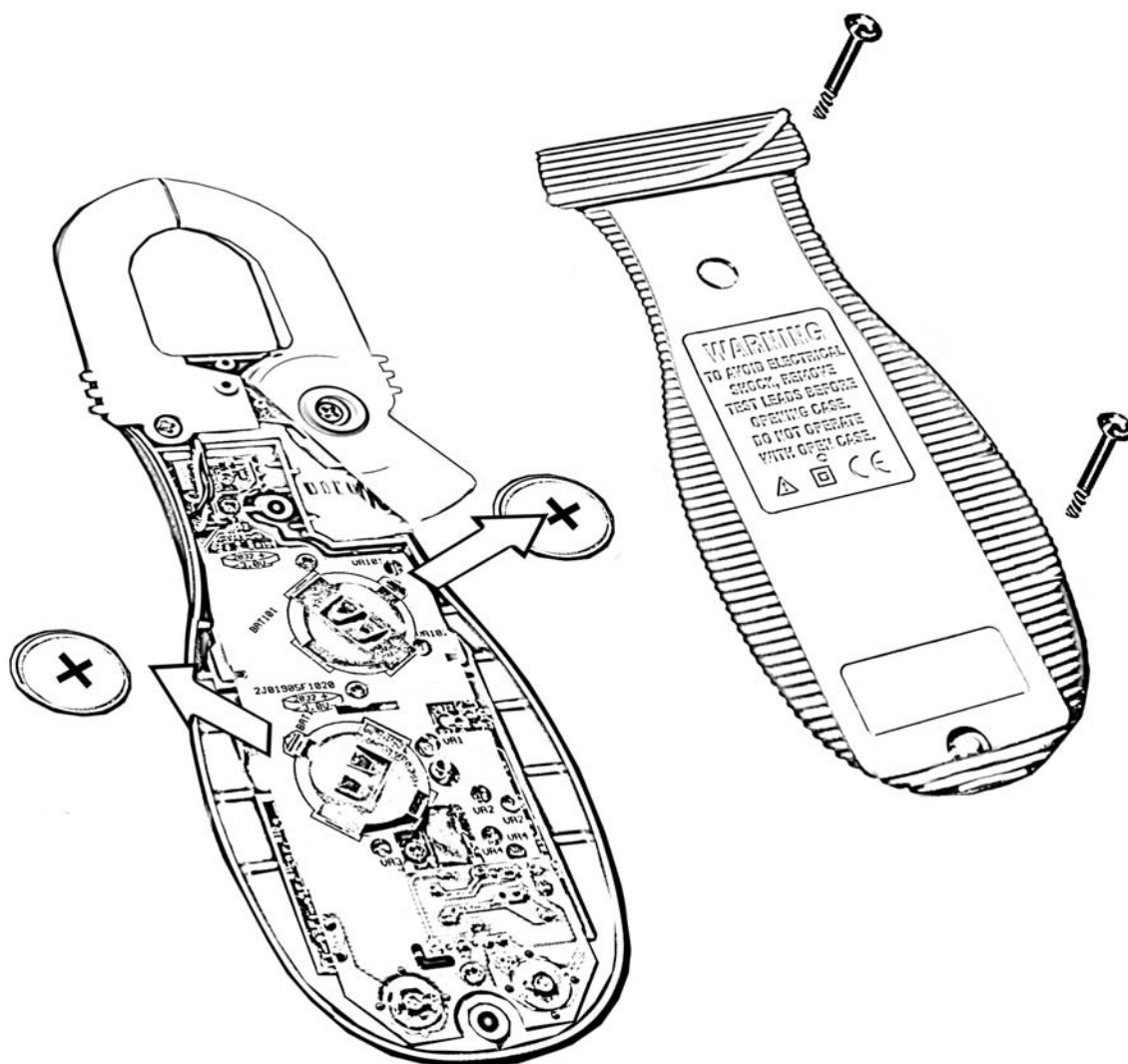

6) Specifications

General Specifications

Display: 3-3/4 digits 4000 counts, dual LCD displays

Update Rate: 3 per second nominal

Polarity: Automatic

Low Battery Indication: Below approx. 2.4V

Operating Temperature: 32°F to 104°F (0°C to 40°C)

Relative Humidity: Maximum relative humidity 80% for temperatures up to 88° F (31°C) decreasing linearly to 50% relative humidity at 104° F (40°C)

Altitude: Operating below 6,562 ft (2000m)

Storage Temperature: -4°F to 140°F (-20°C to 60°C), < 80% R.H. (with battery removed)

Temperature Coefficient: nominal $0.09 \times (\text{specified accuracy})/^\circ\text{F}$ @ 32°F - 64°F or 82°F - 104°F (0°C - 18°C or 28°C - 40°C), or otherwise specified

Sensing: Average sensing

Power Supply: Two 3V alkaline button batteries (ANSI/NEDA-5004LC, IEC-CR2032).

Battery Life: 95 hours approx. (in DCV mode)

Power Consumption: 2.5 mA typical

Low Battery Indication: Below approx. 2.4V (battery symbol appears in upper right)

Auto Power Off: After being idle for 30 minutes

APO Consumption: 0.8μA typical except 25μA typical for temperature function

Dimension: L 7.48" X W 2.48" X H 1.25" (L190mm X W 63mm X H 32mm)

Weight: 0.450 Lb approx. (204 g)

Jaw opening & Conductor diameter: 1.02" max (26mm)

Standard Accessories:

Test leads (pair), banana plug style, bead Type-K Thermocouple, batteries (installed), user's manual, & soft carrying pouch

Replacement Part Numbers:

Test Leads (pair): MTL-90B, Bead Type-K Thermocouple: TPK-59, Carrying Case: SV-U

Safety:

Meets IEC61010-2-032(1994), EN61010-2-032(1995), UL3111-2-032(1999).
Category III 600 Volts AC & DC

CE Approved

UL Listed

Transient protection: 6.5kV (1.2/50μs surge) for all models

Pollution degree: 2

E.M.C.: Meets EN61326(1997, 1998/A1), EN61000-4-2(1995), and EN61000-4-3 (1996)

In an RF field of 3V/m:

Capacitance function is not specified

μ A function: Total Accuracy = Specified Accuracy + 65 digits

Other function ranges: Total Accuracy = Specified Accuracy + 45 digits

Performance above 3V/m is not specified

Overload Protections:

ACA Clamp-on jaws: AC 400A RMS continuous

“+” & “COM” terminals (all functions): 600VDC/VAC RMS

Electrical Specifications

Accuracy is \pm (% reading digits + number of digits) or otherwise specified, at 73°F \pm 9°F (23°C \pm 5°C) & less than 75% R.H.

DC Voltage

RANGE	Accuracy
400.0 mV	0.3% + 4d
4.000V, 40.00V, 400.0V	0.5% + 3d
600V	1.0% + 4d

NMRR: >50dB @ 50/60Hz

CMRR: >120dB @ DC, 50/60Hz,
Rs=1k Ω

Input Impedance: 10M Ω , 30pF nominal
(1000M Ω for 400.0mV range)

AC Voltage

RANGE	Accuracy 1)
50Hz -- 500Hz	
4.000V, 40.00V, 400.0V	1.5% + 5d
600V	2.0% + 5d

CMRR: >60dB @ DC to 60Hz, Rs=1k Ω

Input Impedance: 10M Ω , 30pF nominal

ACA Current (Clamp-on)

RANGE	Accuracy
50Hz / 60Hz	
40.00A	1.9% + 8d
400.0A	1.9% + 8d*
600A**	unspecified

*Accuracy specified to 350A continuous, and 400A for 60-second max with 5 minutes cool down interval

**Added range to indicate instantaneous over-range current values

Max Hold (where applicable)

Specified accuracy \pm 50 digits for changes > 25ms in duration

Audible Continuity Tester

Audible threshold: between 10 Ω and 120 Ω .

Ohms

RANGE	Accuracy
400.0Ω	0.8% + 6d
4.000kΩ, 40.00kΩ, 400.0kΩ	0.6% + 4d
4.000MΩ	1.0% + 4d
40.00MΩ	2.0% + 4d

Open Circuit Voltage: 0.4VDC typical

Capacitance

RANGE*	Accuracy**
500.0nF, 5.000μF, 50.00μF, 500.0μF, 3000μF	3.5%*** + 6d

*Additional 50.00nF range accuracy is not specified

**Accuracies with film capacitor or better

***Specified with battery voltage above 2.8V (approximately half full battery). Accuracy decreases gradually to 12% at low battery warning voltage of approximately 2.4V

DC μA

RANGE	Accuracy	Burden Voltage
400.0μA	1.5% + 4d	2.8mV/μA
2000μA	1.2% + 3d	2.8mV/μA

AC μA

RANGE	Accuracy	Burden Voltage
50Hz -- 500Hz		
400.0μA	2.0% + 5d	2.8mV/μA
2000μA	1.5% + 5d	2.8mV/μA

Hz Frequency

Function	Sensitivity (Sine RMS)	Range
400.0mV	150mV	10Hz -- 2kHz
4.000V	3.2V	5Hz -- 40kHz
40.00V	25V	5Hz -- 100kHz
400.0V	100V	5Hz -- 100kHz
600V	400V	5Hz -- 5kHz
400.0μA	500μA	10Hz -- 30kHz
2000μA	500μA	10Hz -- 30kHz

Display counts: 5000

Best resolution: 0.001Hz

Accuracy: 0.5%+4d

Diode Tester

Open Circuit Voltage	Test Current (Typical)
< 1.6 VDC	0.25mA

Type-K Temperature

RANGE	Accuracy*
-20°C TO 300°C	2% + 3°C
-4°F TO 572°F	2% + 6°F

*Type-K thermocouple range & accuracy not included

LIMITED WARRANTY

Your AMPROBE instrument has a limited warranty against defective materials and/or workmanship for one year from the date of purchase provided that, in the opinion of the factory, the instrument has not been tampered with or taken apart.

Should your instrument fail due to defective materials, and/or workmanship during this 1-year period, a no charge repair or replacement will be made to the original purchaser. Please have your dated bill of sale, which must identify the instrument model number and serial number and call the number listed below:

Outside the U.S.A. the local representative will assist you.

Note: Please obtain an RMA number before returning product for repair.

**Call: Customer Service - Repair
1-800-327-5060**



Advanced Test Products - AMPROBE
Miramar, FL
Tel.: (954)499-5400
Fax: (954)499-5454



PRINTED ON RECYCLABLE PAPER, PLEASE RECYCLE
COPYRIGHT © MMIII Btc,

ALL RIGHTS RESERVED

P/N:7M1C-0511-0000

PRINTED IN TAIWAN